

Intelligent LED Driver (Constant Current)

- Dimming interface: DMX512/RDM, Push DIM.
- Support RDM remote device management protocol.
- T-PWM™ digital dimming, present a perfect visual experience.
- Dimming range: 0-100%, LED start at 0.01% possible.
- With soft-on and fade in function, visual more comfortable.
- 0-100% flicker free, High frequency exemption level.
- DIP switch for 8 optional currents' quick selection, ISET arbitrarily current selection.
- Innovative thermal management technology, intelligent power life protection.
- Multi-current & wide voltage, suitable for different power LED.
- Short circuit / Over-heat / Over load / Non-load protection, recover automatically.
- Non-load output voltage 0V to prevent damages to LED caused by poor contact.
- Suitable for internal lights application for I / II / III.
- Up to 50,000-hour life time
- 5 years warranty (Rubycon capacitor).



T-PWM™
Super depth dimming technology

Flicker-Free
IEEE 1789

Dimmable:
0.01% - 100%



Specification

Model	DMX-15-100-700-U1P1	DMX-25-150-900-U1P1	DMX-36-200-1200-U1P1	
OUTPUT	Output Voltage	10-54Vdc		
	Max Output Voltage	58Vdc		
	Non-load Output Voltage:	0Vdc		
	Output Current	100-700mA	150-900mA	200-1200mA
	Output Power	1-15W	1.5-25W	2-36W
	Strobe Level	No video flicker / High frequency exemption assessment level		
	Dimming Range	0-100%, 0.01% dimming depth.		
	PWM Dimming Frequency	≤3600Hz		
	LF Current Ripple(120Hz)	<2%		
	Current Accuracy	±5%		
Ripple & Noise	≤2V			
INPUT	Dimming Interface	DMX512/RDM, Push DIM		
	Input Voltage	100-277Vac, (Max. 90-305Vac)		
	Frequency	50/60Hz		
	Input Current	115Vac≤0.2A, 230Vac≤0.12A, 277Vac≤0.1A	115Vac≤0.3A, 230Vac≤0.2A, 277Vac≤0.15A	115Vac≤0.45A, 230Vac≤0.25A, 277Vac≤0.2A
	Power Factor	PF>0.97/115Vac, PF>0.9/230Vac, PF>0.88/277Vac (full load)	PF>0.97/115Vac, PF>0.93/230Vac, PF>0.85/277Vac (full load)	PF>0.95/115Vac, PF>0.9/230Vac, PF>0.85/277Vac (full load)
	THD	<16%/115Vac, <20%/230Vac, <29%/277Vac, (full load)	<16%/115Vac, <20%/230Vac, <22%/277Vac, (full load)	
	Efficiency(typ.)	82%	85%	88%
	Inrush Current(typ.)	Cold start 8A at 230Vac (twidth=75µs measured at 50% Ipeak)	Cold start 10A at 230Vac (twidth=75µs measured at 50% Ipeak)	Cold start 20A at 230Vac (twidth=75µs measured at 50% Ipeak)
Anti Surge	L-N: 1kV			
Leakage Current	<0.5mA/230Vac			
ENVIRONMENT	Working Temperature	ta: -30°C ~ 55°C tc: 75°C		
	Working Humidity	20 ~ 95%RH, non-condensing		
	Storage Temp., Humidity	-40°C ~ 80°C, 10-95%RH		
	Temp. Coefficient	±0.03%/°C (0-50°C)		
	Vibration	10-500Hz, 2G 12min./1cycle, period for 72min. each along X, Y, Z axes		
PROTECTION	Over-heat Protection	Intelligently adjusting or turning off the output current if the PCB temperature ≥110°C, auto recovers		
	Over Load Protection	Shut down the output when current load ≥102%, auto recovers		
	Short Circuit Protection	Shut down automatically if short circuit occurs, auto recovers		
	Non-load Protection:	Shut down the output if no load, auto recovers when load back to normal		
SAFETY & EMC	Withstand Voltage	I/P-O/P: 3750Vac		
	Isolation Resistance	I/P-O/P: 100MΩ/500VDC/25°C/70%RH		
	Safety Standards	UL	America	UL8750
		CUL	Canada	CSA C22.2 No. 250. 13
		CE	European Union	EN61347-1, EN61347-2-13, EN62384
	EMC Emission	FCC	America	FCC part 15
		CE	European Union	EN55015, EN61000-3-2, EN61000-3-3
EMC Immunity	EN61000-4-2,3,4,5,6,8,11 EN61547			
Strobe Test Standard	IEEE 1789			
OTHERS	Dimension	175×44×30mm(L×W×H)		
	Packing	178×48×33mm(L×W×H)		
	Weight(G.W.)	175g±10g		

LED Current Selection

DIP switch for 8 optional currents' quick selection(see the table below).

DMX-15-100-700-U1P1	DIP Switch	⬇⬇⬇	⬇⬇⬆	⬇⬆⬇	⬇⬆⬆	⬆⬇⬇	⬆⬇⬆	⬆⬆⬇	⬆⬆⬆	⬆ ⬇ ON OFF
	Output Current	100mA	180mA	300mA	350mA	450mA	500mA	600mA	700mA	
	Output Voltage	10-54V	10-54V	10-50V	10-43V	10-34V	10-30V	10-25V	10-22V	
	Output Power	1W-5.4W	1.8W-9.72W	3W-15W	3.5W-15.05W	4.5W-15.3W	5W-15W	6W-15W	7W-15.4W	

DMX-25-150-900-U1P1	DIP Switch	⬇⬇⬇	⬇⬇⬆	⬇⬆⬇	⬇⬆⬆	⬆⬇⬇	⬆⬇⬆	⬆⬆⬇	⬆⬆⬆	⬆ ⬇ ON OFF
	Output Current	150mA	250mA	300mA	350mA	500mA	600mA	700mA	900mA	
	Output Voltage	10-54V	10-54V	10-54V	10-54V	10-50V	10-42V	10-36V	10-28V	
	Output Power	1.5W-8.1W	2.5W-13.5W	3W-16.2W	3.5W-18.9W	5W-25W	6W-25.2W	7W-25.2W	9W-25.2W	

DMX-36-200-1200-U1P1	DIP Switch	⬇⬇⬇	⬇⬇⬆	⬇⬆⬇	⬇⬆⬆	⬆⬇⬇	⬆⬇⬆	⬆⬆⬇	⬆⬆⬆	⬆ ⬇ ON OFF
	Output Current	200mA	350mA	500mA	600mA	700mA	900mA	1050mA	1200mA	
	Output Voltage	10-54V	10-54V	10-54V	10-54V	10-52V	10-40V	10-35V	10-30V	
	Output Power	2W-10.8W	3.5W-18.9W	5W-27W	6W-32.4W	7W-36.4W	9W-36W	10.5W-36.75W	12W-36W	

- * Please choose the current value when the driver is power off.
- * E.g. LED 3V/pcs: 10-54V can power 3-18pcs LEDs in series, 10-30V can power 3-10pcs LEDs, the max quantity of LEDs in series will be subject to the actual voltage of LED.
- * Setting DMX address via RDM function

Advanced options: connect ISET port with resistors of different values to set up currents

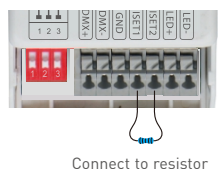

DMX-15-100-700-U1P1	Current(mA)	140mA	180mA	220mA	260mA	300mA	340mA	380mA	420mA	460mA	500mA
	Resistor(KΩ)	33.93 KΩ	27.78KΩ	23.19 KΩ	19.32KΩ	16.34 KΩ	14.05 KΩ	11.96KΩ	10.17 KΩ	8.57KΩ	7.16 KΩ
DMX-25-150-900-U1P1	Current(mA)	200mA	250mA	300mA	350mA	400mA	450mA	500mA	550mA	600mA	650mA
	Resistor(KΩ)	34KΩ	26.93KΩ	22.3KΩ	18.98 KΩ	15.93 KΩ	13.31 KΩ	11.45 KΩ	9.53KΩ	8.23 KΩ	6.72KΩ
DMX-36-200-1200-U1P1	Current(mA)	250mA	300mA	350mA	400mA	450mA	500mA	550mA	600mA	650mA	700mA
	Resistor(KΩ)	41.6KΩ	34.7 KΩ	29.52KΩ	25.4 KΩ	21.9 KΩ	19 KΩ	16.66 KΩ	14.5KΩ	12.62 KΩ	11.19KΩ
	Current(mA)	750mA	800mA	850mA	900mA	950mA	1000mA	1050mA	1100mA	1150mA	
	Resistor(KΩ)	9.8 KΩ	8.57 KΩ	7.43 KΩ	6.42 KΩ	5.47 KΩ	4.65 KΩ	3.93 KΩ	3.2 KΩ	2.57 KΩ	

Dimensions

Unit: mm

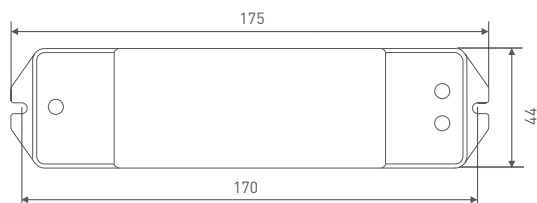

Wiring Diagram

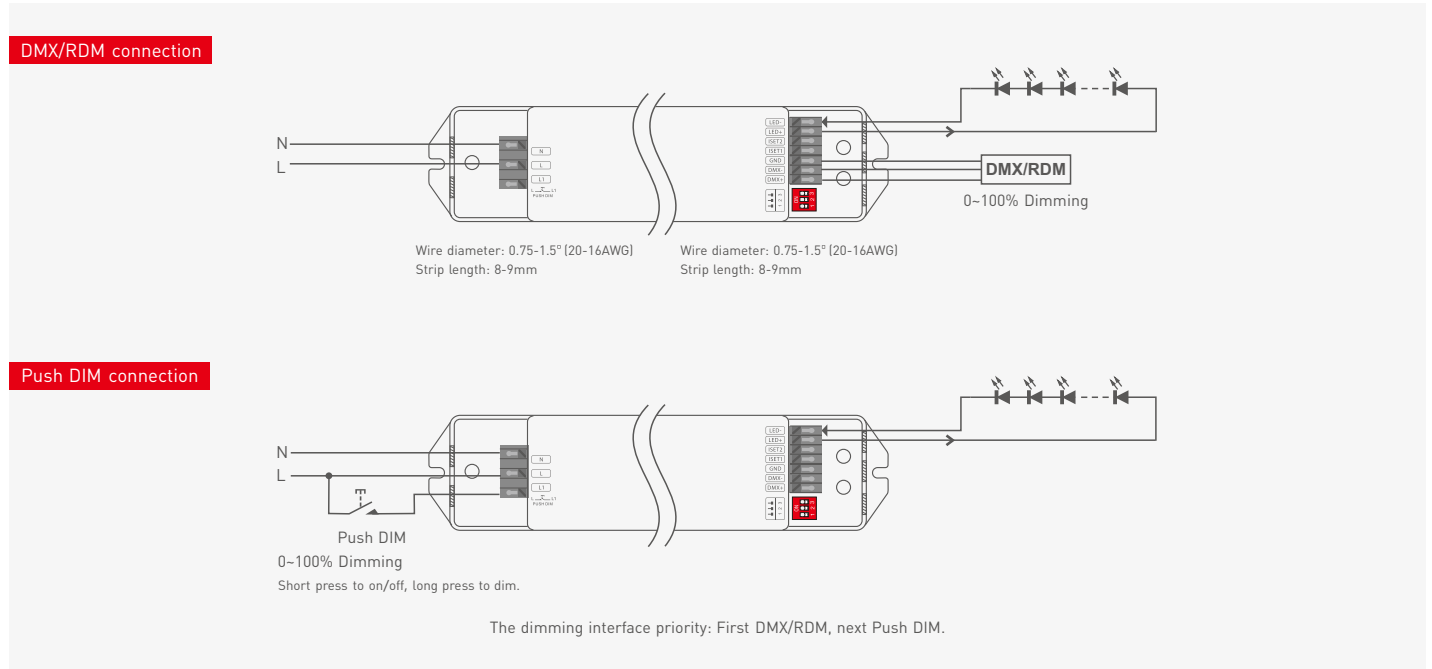

Push DIM



Reset Switch

- On/off control: Short press.
- Stepless dimming: Long press.
- With every other long press, the brightness goes to the opposite direction.
- Dimming memory: Brightness will be the same as previously adjusted when turning off and on again.

DMX Address Setting

The DMX driver can work with the address editor that complies with standard RDM protocol. It is recommended to use LTECH's RDM editor (model WiFi-RDM01), which can achieve more functions such as remote browsing and parameter setting. Wiring diagram as below:

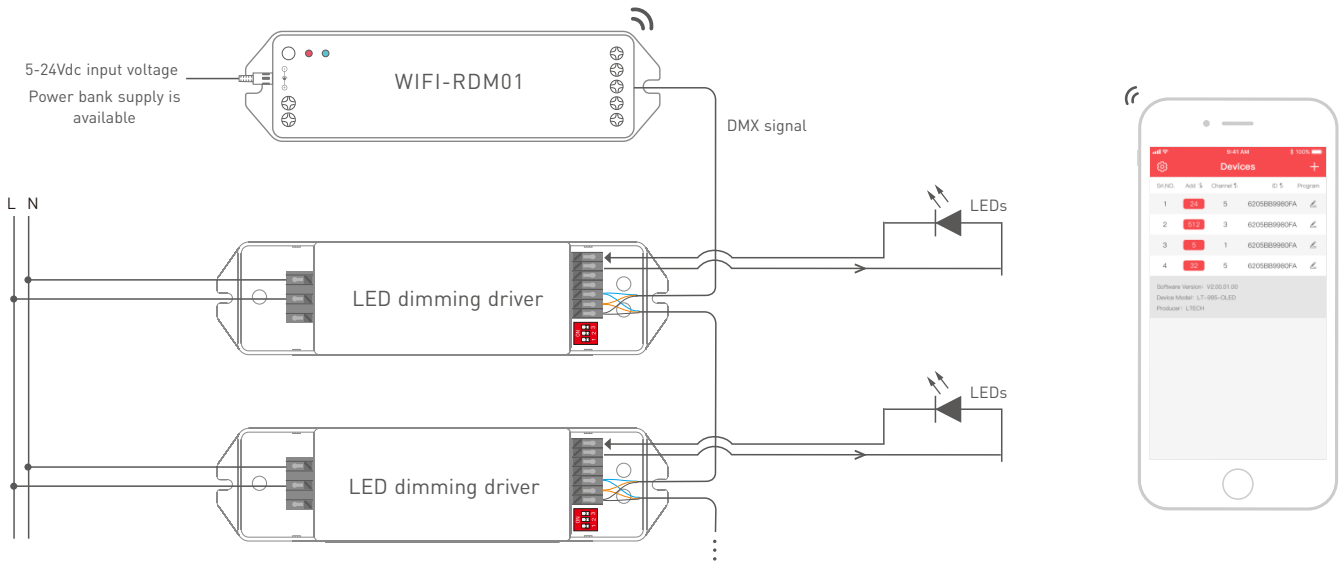

* the defaulted DMX address of the driver is 1.

LTECH RDM editor App interface instruction

Download the App, setting the parameters after well connecting the RDM editor, please check the manual of WiFi-RDM01 for more details.

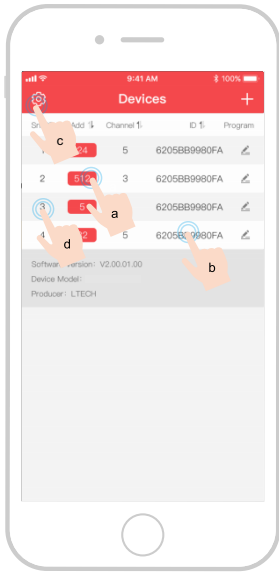

- a: Click "Add", edited the address in corresponding box.
- b: Click "ID", get more product details.
- c: Click "⚙️", enter setting interface.
- d: Click "No.", issue the recognizing command.

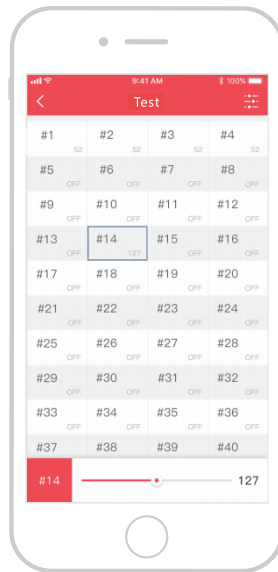

Test

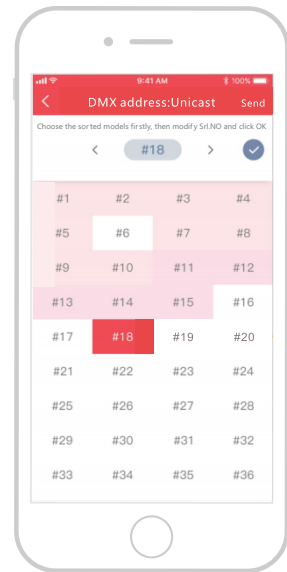

DMX address setting

Flicker Test Form

IEEE 1789

Limit of Modulation in low risk area	
Waveform frequency of Optical output	limit [%]
$f \leq 8\text{Hz}$	0.2
$8\text{Hz} < f \leq 90\text{Hz}$	$0.025 \times f$
$90\text{Hz} < f \leq 1250\text{Hz}$	$0.08 \times f$
$f > 1250\text{Hz}$	Exemption assessment
Limit of Modulation in no effect area	
Waveform frequency of Optical output	limit [%]
$f \leq 10\text{Hz}$	0.1
$10\text{Hz} < f \leq 90\text{Hz}$	$0.01 \times f$
$90\text{Hz} < f \leq 3125\text{Hz}$	$[0.08/2.5] \times f$
$f > 3125\text{Hz}$	Exemption assessment (High frequency exemption)

Brightness

- ▲ 0.1%
- ◆ 1%
- ▲ 5%
- ◆ 10%
- 20%
- 30%
- 40%
- ★ 50%
- 60%
- 70%
- 80%
- ★ 90%
- ◆ 100%

Modulation Area Diagram
High Frequency Exemption Area Diagram

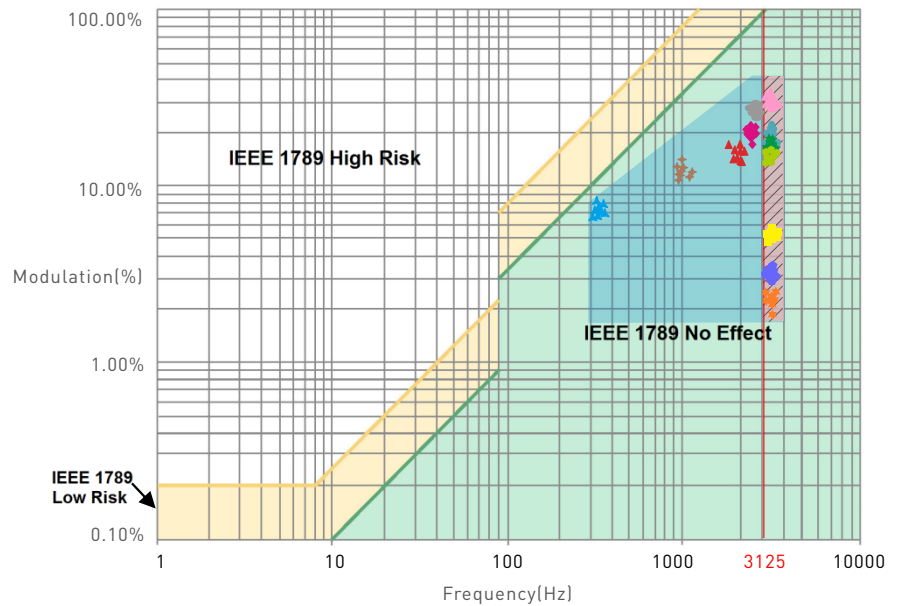

Marks in the right chart were tested results of different current ranges. The output frequency is 0Hz in 100% brightness and its corresponding modulation is 0%, which could not be shown in the right chart.

Attentions

- Products shall be installed by qualified professionals.
 - LTECH products are non-waterproof (special models excepted). Please avoid the sun and rain. When installed outdoors, please ensure it is mounted in a water proof enclosure.
 - Good heat dissipation will extend the working life of products. Please ensure good ventilation.
 - Please check if the working voltage used complies with the parameter requirements of products.
 - The diameter of wire used must be able to load the light fixtures you connect and ensure the firm wiring.
 - Before you power on products, please make sure all the wiring is correct in case of incorrect connection that causes damage to light fixtures.
 - If a fault occurs, please do not attempt to fix products by yourself. If you have any question, please contact your suppliers.
- * This manual is subject to changes without further notice. Product functions depend on the goods. Please feel free to contact our official distributors if you have any question.

Warranty Agreement

- Warranty periods from the date of delivery 5 years.
- Free repair or replacement services for quality problems are provided within warranty periods.

Warranty exclusions below:

- Beyond warranty periods.
- Any artificial damage caused by high voltage, overload, or improper operations.
- Products with severe physical damage.
- Damage caused by natural disasters and force majeure.
- Warranty labels and barcodes have been damaged.
- No any contract signed by LTECH.

1. Repair or replacement provided is the only remedy for customers. LTECH is not liable for any incidental or consequential damage unless it is within the law.
2. LTECH has the right to amend or adjust the terms of this warranty, and release in written form shall prevail

Update Log

Version	Updated Time	Update Content	Updated by
A3	2019.10.24	Add RDM editor connection diagram	Huang Yunting
A4	2021.12.10	Update product silk screen, TUV certification icon; add precautions and warranty agreement	Liu Weili
A5	2022.04.27	Update product certification icons	Liu Weili