



■ **Features**

- Ultra slim
- Universal AC input / Full range
- 2 pole USA plug, Class II power unit
- No load power consumption <0.075W for 5~7.5V
<0.15W for 9 ~48V
- **Energy efficiency Level VI**
- Comply with EISA 2007/DoE
- Protections: Short circuit / Overload / Over voltage
- Fully enclosed plastic case
- Pass LPS
- LED indicator for power on
- 3 years warranty

■ **Applications**

- Consumer electronic devices
- Telecommunication devices
- Office facilities
- Industrial equipments

■ **Description**

SGA60U is a 60W ultra slim wall-mounted style single-output green adaptor series, which is compact and convenient for carry. SGA60U is a class II power unit (no FG) equipped with the standard 2-Pin U.S. plug, accepting the input range from 90VAC to 264VAC. The whole series provides different models with output voltages ranging between 5VDC and 48VDC that it can satisfy the demands for various types of consumer electronic devices.

With the efficiency up to 91% and the extremely low no-load power consumption below 0.075W for 5~7.5V, below 0.15W for 9 ~48V, SGA60U is compliant with the latest U.S. energy regulation EISA 2007/DoE(Level VI). The supreme feature allows the adaptor to save the energy when it is under either the operating mode or the standby mode. The entire series is approved for international safety regulations; moreover, it adopts the 94V-0 flame retardant plastic case that it can effectively prevent users from electric hazards.

■ **Model Encoding**

SGA 60 U 05 -P1J

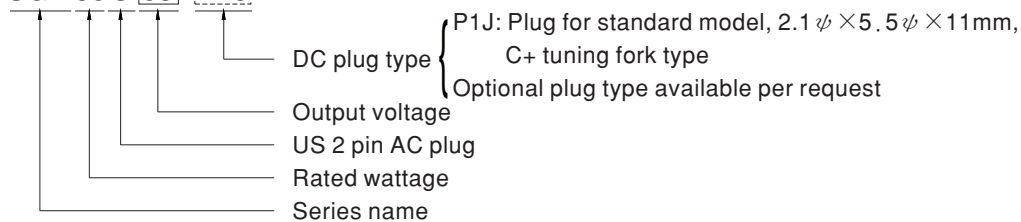



60W AC-DC High Reliability Slim Wall-mounted Adaptor

SGA60U series

SPECIFICATION

ORDER NO.	SGA60U05-P1J	SGA60U07-P1J	SGA60U09-P1J	SGA60U12-P1J	SGA60U15-P1J	SGA60U18-P1J	SGA60U24-P1J	SGA60U48-P1J		
OUTPUT	SAFETY MODEL NO.	SGA60U05	SGA60U07	SGA60U09	SGA60U12	SGA60U15	SGA60U18	SGA60U24	SGA60U48	
	DC VOLTAGE Note.2	5V	7.5V	9V	12V	15V	18V	24V	48V	
	RATED CURRENT	6A	6A	5.5A	5A	4A	3.33A	2.5A	1.25A	
	CURRENT RANGE	0 ~ 6A	0 ~ 6A	0 ~ 5.5A	0 ~ 5A	0 ~ 4A	0 ~ 3.33A	0 ~ 2.5A	0 ~ 1.25A	
	RATED POWER (max.)	30W	45W	49.5W	60W	60W	60W	60W	60W	
	RIPPLE & NOISE (max.) Note.3	80mVp-p	80mVp-p	80mVp-p	80mVp-p	80mVp-p	80mVp-p	100mVp-p	120mVp-p	
	VOLTAGE TOLERANCE Note.4	±5.0%	±5.0%	±5.0%	±3.0%	±3.0%	±2.0%	±2.0%	±2.0%	
	LINE REGULATION Note.5	±1.0%	±1.0%	±1.0%	±1.0%	±1.0%	±1.0%	±1.0%	±1.0%	
	LOAD REGULATION Note.6	±5.0%	±5.0%	±5.0%	±3.0%	±3.0%	±2.0%	±2.0%	±2.0%	
	SETUP, RISE, HOLD UP TIME	500ms, 50ms, 12ms/230VAC 500ms, 50ms, 12ms/115VAC at full load								
INPUT	VOLTAGE RANGE Note.7	90 ~ 264VAC								
	FREQUENCY RANGE	47 ~ 63Hz								
	EFFICIENCY (Typ.)	84%	86%	87%	88%	87%	88%	88%	91%	
	AC CURRENT	1.5A / 115VAC 0.75A / 230VAC								
	INRUSH CURRENT (max.)	Cold start 40A / 115VAC 80A / 230VAC								
	LEAKAGE CURRENT(max.)	0.25mA / 240VAC								
PROTECTION	OVERLOAD	110 ~ 200% rated output power Protection type : Hiccup mode, recovers automatically after fault condition is removed								
	OVER VOLTAGE	110 ~ 140% rated output voltage Protection type : Clamp by zener diode, output short								
ENVIRONMENT	WORKING TEMP.	-20 ~ +50°C (Refer to "Derating Curve")								
	WORKING HUMIDITY	20% ~ 90% RH non-condensing								
	STORAGE TEMP., HUMIDITY	-20 ~ +85°C, 10 ~ 95% RH non-condensing								
	TEMP. COEFFICIENT	±0.03% / °C (0 ~ 40°C)								
	VIBRATION	10 ~ 500Hz, 2G 10min./1cycle, period for 60min. each along X, Y, Z axes								
SAFETY & EMC (Note. 8)	SAFETY STANDARDS	UL60950-1, CSA C22.2, EAC TP TC 004 approved								
	WITHSTAND VOLTAGE	I/P-O/P:4242VDC								
	ISOLATION RESISTANCE	I/P-O/P:100M Ohms / 500VDC / 25°C / 70% RH								
	EMC EMISSION	Parameter	Standard					Test Level / Note		
	Conducted emission	FCC PART 15 / CISPR22, CAN ICES-3(B)/NMB-3(B)					Class B			
	Radiated emission	FCC PART 15 / CISPR22, CAN ICES-3(B)/NMB-3(B)					Class B			
OTHERS	LIFE	3 years : 100% load 40°C, 12hours / day								
	MTBF	400Khrs min. MIL-HDBK-217F(25°C)								
	DIMENSION	93.5*35*51.5mm (L*W*H)								
	PACKING	250g ; 60pcs / 17kg / CARTON								
CONNECTOR	PLUG	See page 4~5 ; Other type available by customer requested								
	CABLE	See page 4~5 ; Other type available by customer requested								
NOTE	<p>1.All parameters are specified at 115VAC input, rated load, 25°C 70% RH ambient.</p> <p>2.DC voltage: The output voltage set at point measure by plug terminal & 50% load.</p> <p>3.Ripple & noise are measured at 20MHz by using a 12" twisted pair terminated with a 0.1µf & 47µf capacitor.</p> <p>4.Tolerance: includes set up tolerance, line regulation, load regulation.</p> <p>5.Line regulation is measured from low line to high line at rated load.</p> <p>6.Load regulation is measured from 10% to 100% rated load.</p> <p>7.Derating may be needed under low input voltages. Please check the static characteristics for more details.</p> <p>8.The power supply is considered as an independent unit, but the final equipment still need to re-confirm that the whole system complies with the EMC directives. For guidance on how to perform these EMC tests, please refer to "EMI testing of component power supplies." (as available on http://www.meanwell.com)</p>									



Derating Curve

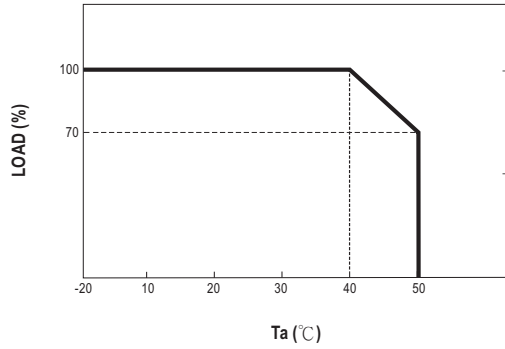

Static Characteristics

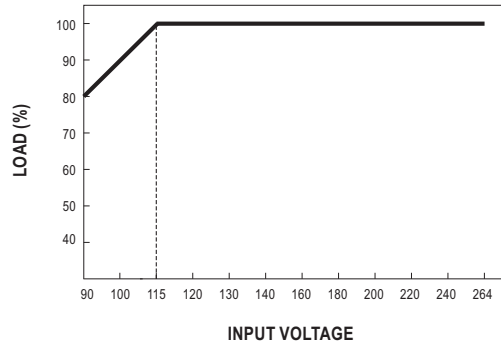

Mechanical Specification

Unit:mm

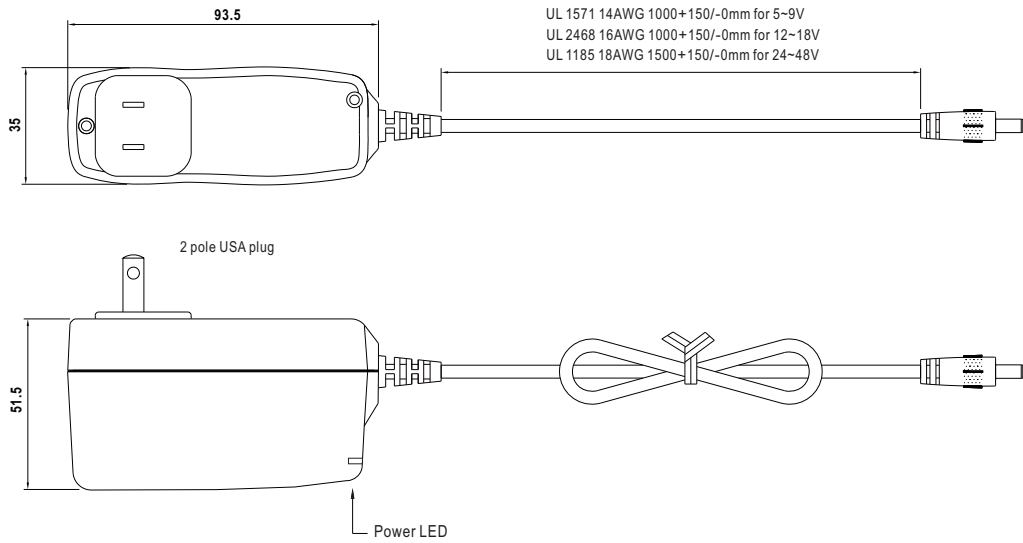











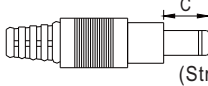
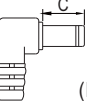

DC output plug

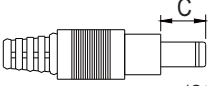
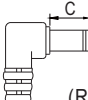
Standard plug: P1J

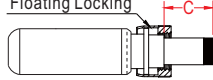

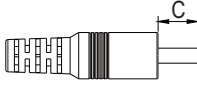

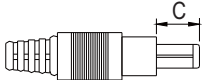
Unit:mm

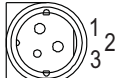
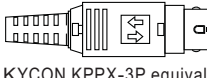
P1J	Pin Assignment
	Outside ⊖ ⊕ Inside

◎ Optional DC plug:

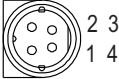
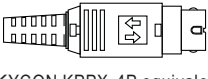
Tuning Fork Style		Type No.	A	B	C		
 	 (Straight)	P1I	5.5	2.1	9.5		
		P1L	5.5	2.5	9.5		
		P1M	5.5	2.5	11.0		
		P1IR	5.5	2.1	9.5		
		P1JR	5.5	2.1	11.0		
		P1LR	5.5	2.5	9.5		
		P1MR	5.5	2.5	11.0		
 (Right-angled)							
	Barrel Style		Type No.	A	B	C	
	 	 (Straight)	P2I	5.5	2.1	9.5	
			P2J	5.5	2.1	11.0	
			P2L	5.5	2.5	9.5	
			P2M	5.5	2.5	11.0	
			P2IR	5.5	2.1	9.5	
P2JR			5.5	2.1	11.0		
P2LR			5.5	2.5	9.5		
P2MR			5.5	2.5	11.0		
 (Right-angled)							
			Lock Style		Type No.	A	B
	 	 Floating Locking SWITCHCRAFT original or equivalent	P2S(S761K)	5.53	2.03	12.06	
			P2K(761K)	5.53	2.54	12.06	
			P2C(S760K)	5.53	2.03	9.52	
			P2D(760K)	5.53	2.54	9.52	
	Min. Pin Style		Type No.	A	B	C	
	 	 EIAJ equivalent	P3A	2.35	0.7	11.0	
			P3B	4.0	1.7	11.0	
P3C			4.75	1.7	11.0		
Center Pin Style		Type No.	A	B	C	D	
 	 EIAJ equivalent	P4A	5.5	3.4	11.0	1.0	
		P4B	6.5	4.4	11.0	1.4	
		P4C	7.4	5.1	11.0	0.6	
Min. DIN 3 Pin with Lock (male)		Type No.	Pin Assignment				
 	 KYCON KPPX-3P equivalent		PIN No.	Output			
		R6B	1	+Vo			
		2	-Vo				
		3	+Vo				

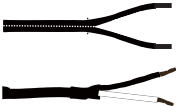
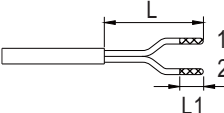

Min. DIN 4 Pin with Lock (male)	Type No.	Pin Assignment	
		PIN No.	Output
   <p>KYCON KPPX-4P equivalent</p>	R7B	1	+Vo
		2	-Vo
		3	-Vo
		4	+Vo
Min. DIN 4 Pin with Lock (female)	Type No.	Pin Assignment	
   <p>KYCON KPJX-CM-4S equivalent</p>	R7BF	1	+Vo
		2	-Vo
		3	-Vo
		4	+Vo
Stripped and tinned leads	Type No.	Pin Assignment	
  <p>Length of Land L1 by request (MW's standard length, L: <u>25</u> mm, L1: <u>10</u> mm)</p>	by customer	1 (Ribbed or White)	+Vo
		2 (Letter or Black)	-Vo

■ **Installation Manual**

Please refer to : <http://www.meanwell.com/manual.html>